

Ronix®

Premium Quality

CROSS LINE LASER LEVEL

RH-9500

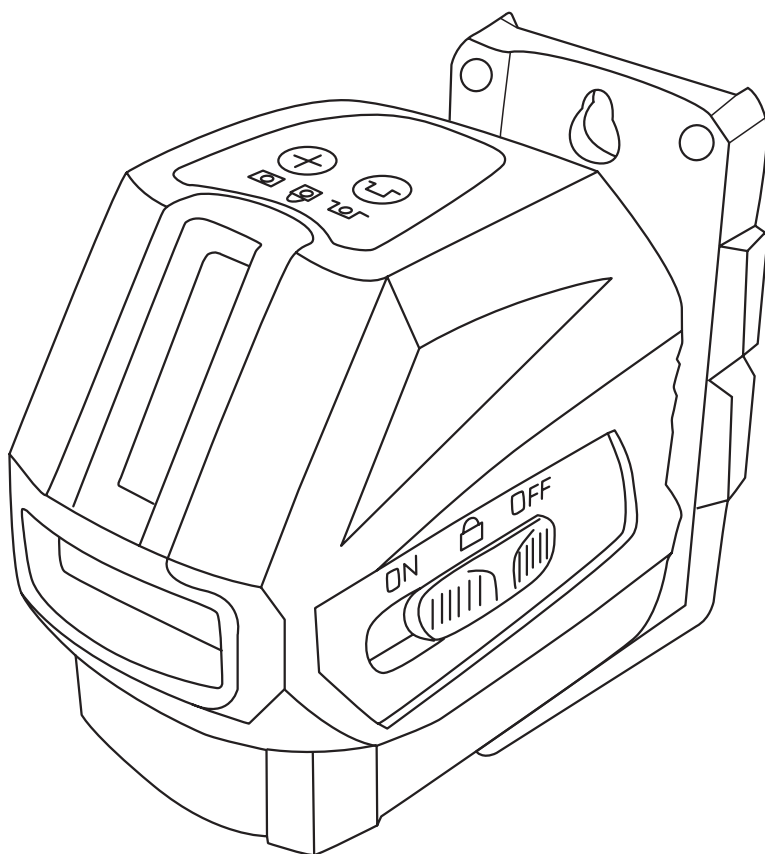

www.ronixtools.com



SPECIFICATIONS

Model	RH-9500
Accuracy of horizontal line	± 2 mm @ 5m
Vertical accuracy	± 2 mm @ 5m
Leveling Range	4°±0.5°
Working Range/ With Detector	15m/50m with detector
Tripod Thread	1/4 "
Laser Type	635 nm, laser class II
Operating Temperature	-10°to 45°C
Storage Temperature	-20°to 60°C
Dimension	119 × 62 × 95/cm3
Continuous Working Time (All Diodes)	≥ 8hour
Power Supply	3 × AA Alkaline batteries

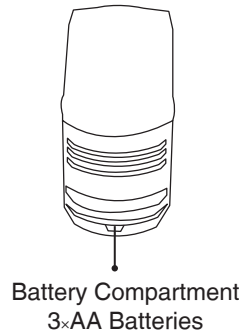
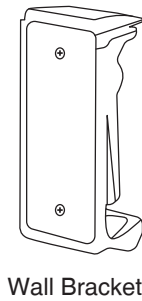
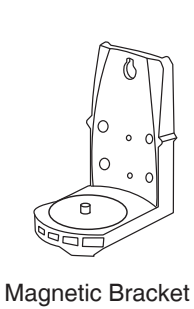
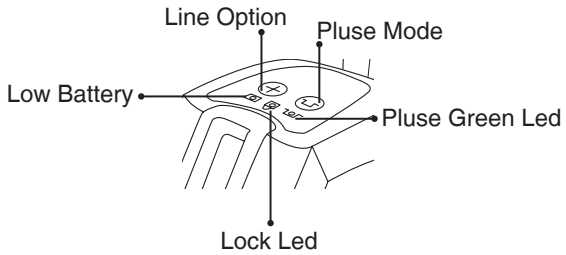
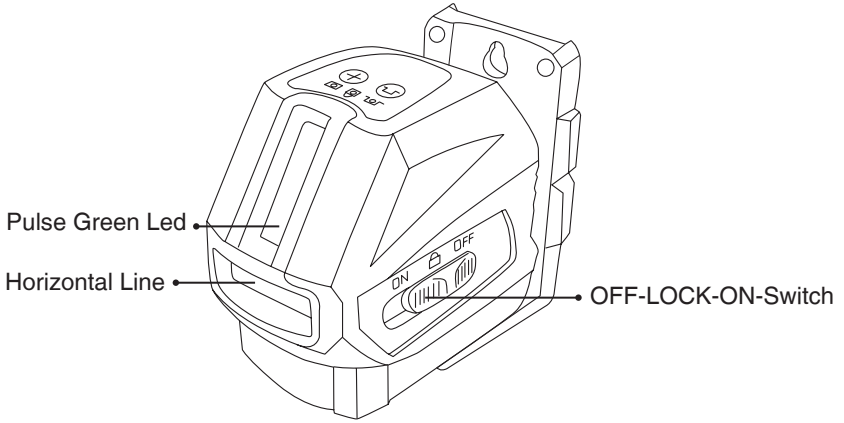



Please read this instruction manual before first use.

■ WHAT IS INCLUDED WITH YOUR RED BEAM LASER

- 1- Instrument
- 2- Magnetic bracket and wall bracket
- 3- Alkaline batteries
- 4- User manual
- 5- Plastic Case

OPERATING THE UNIT

■ PENDULUM LOCK

The 1V1H Red beam laser level is a precision instrument and should be treated with care. When not in use, the pendulum should always be in the Off position (Figure 1). Locking the pendulum allows the Cross Line Laser to better withstand vibration and trauma incurred during transportation or if the unit is dropped.



■ LOCKED LINE ANGLE

In the locked line angle position (figure 2), the pendulum is in the locked position and will not automatically level. When in the locked line position, both two laser lines will be on and flash slowly. The Red Lock LED will be on as well.



■ AUTOMATIC LEVELING

When the pendulum is unlocked (figure 3), the pendulum is free to automatically level. In order for the Cross Line Laser to automatically level, the base of the unit needs to be within 4° of level.

When the pendulum is unlocked and the Cross Line Laser is within 4°

of level, the unit will be in automatic leveling range, in this situation no LED light will be on. Should the base of the unit be outside the 4⁰ leveling range the laser beam will flash meanwhile an audibly warning will be sent out from Cross Line Laser.

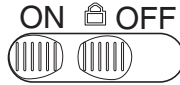

■ LOW BATTERY ALARM

The Green battery LED will be on and keep flashing slowly when the working voltage of laser is below 3V. At this situation the batteries are required to be replaced.

Ronix[®]
Premium Quality